

# Product Catalog

The leader in lightweight durability





# Shipping May 2006!



## SwiftSet® Courtside™

- Classic SwiftSet® design
- Safe, convenient flip seat
- Easy set-up



SwiftSet® Courtside™  
Flip seat folding chair



SwiftSet® HD™  
High density stacking chair

## SwiftSet® HD™

- Straight-up stacking for more efficient storage
- Durable chrome legs
- Available in a variety of colors



### Tables

Mity-Lite tables are lightweight yet tough enough to handle rigorous use. See our table solutions starting on [page 2](#).



### Chairs

Our award winning chairs are lightweight, stylish and comfortable. Find your perfect seating solution starting on [page 6](#).



### Lecterns

Summit™ Lecterns from Mity-Lite are easy to handle and highly resistant to damage. For lectern details, please see [page 15](#).



### Partitions

VersiPanel™ and VersiFold™ Portable Partitions help you maximize your existing space. Learn about our portable partitions on [page 16](#).



### Carts

Mity-Lite carts easily transport and protect your multi-purpose furniture. See all Mity-Lite table and chair carts on [pages 18-19](#).



### Accessories

Give your Mity-Lite furniture a custom look. See our wide variety of accessories on [page 20](#).

---

**100% financing available**

---



*Mity-Lite® tables come in over 50 sizes and are engineered for many years of reliable service! Here are just a few standard features we include to ensure your confidence in our tables:*

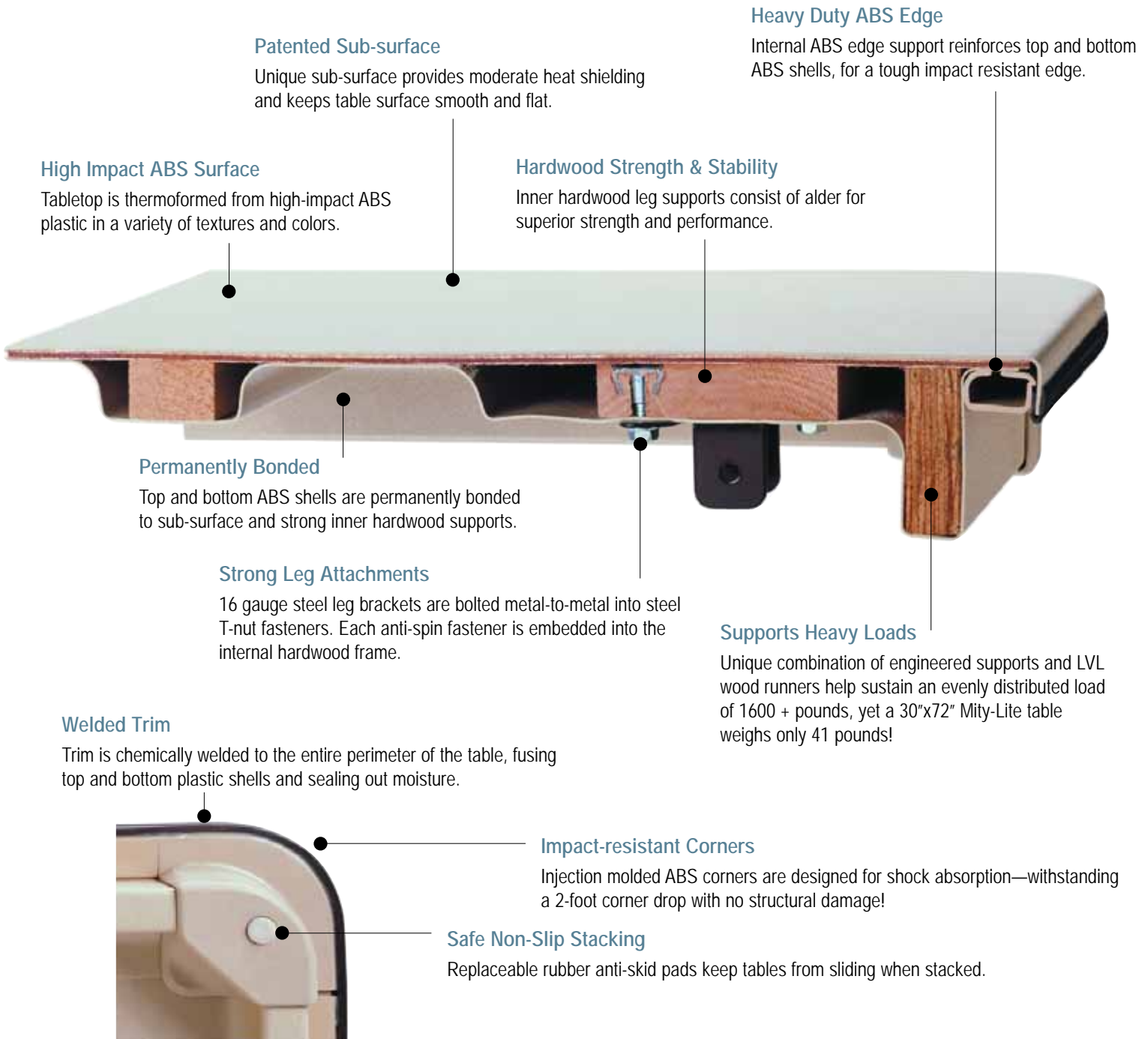

**Patented Sub-surface**

Unique sub-surface provides moderate heat shielding and keeps table surface smooth and flat.

**Heavy Duty ABS Edge**

Internal ABS edge support reinforces top and bottom ABS shells, for a tough impact resistant edge.

**High Impact ABS Surface**

Tabletop is thermoformed from high-impact ABS plastic in a variety of textures and colors.

**Hardwood Strength & Stability**

Inner hardwood leg supports consist of alder for superior strength and performance.

**Permanently Bonded**

Top and bottom ABS shells are permanently bonded to sub-surface and strong inner hardwood supports.

**Strong Leg Attachments**

16 gauge steel leg brackets are bolted metal-to-metal into steel T-nut fasteners. Each anti-spin fastener is embedded into the internal hardwood frame.

**Supports Heavy Loads**

Unique combination of engineered supports and LVL wood runners help sustain an evenly distributed load of 1600 + pounds, yet a 30"x72" Mity-Lite table weighs only 41 pounds!

**Welded Trim**

Trim is chemically welded to the entire perimeter of the table, fusing top and bottom plastic shells and sealing out moisture.

**Impact-resistant Corners**

Injection molded ABS corners are designed for shock absorption—withstanding a 2-foot corner drop with no structural damage!

**Safe Non-Slip Stacking**

Replaceable rubber anti-skid pads keep tables from sliding when stacked.



*Need more info? Give us a call at 1-800-327-1692.*

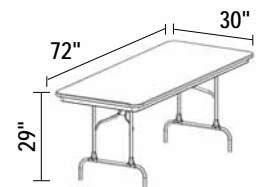

Tables are standard 29" high, 30" upon request

*Mity-Lite's lightweight folding tables really last!*



Mity-Lite's pioneering table design includes a patented internal structure that helps support more than 1600 pounds.

For info on more than 50 table sizes, call 1-800-327-1692 to speak with a friendly Mity-Lite representative.

Need chairs to go with your tables?

Our lightweight folding and stacking chairs complement any Mity-Lite table. See page 6 for details.

**Benefits:**

- Light enough for one person to carry
- Much more durable than hollow plastic tables
- Strong leg attachments can't be pulled loose
- Less wear and tear with reinforced corners and edges
- Easy handling cuts set-up and take down time
- Longer lasting tables reduce ownership costs
- World renowned customer service

**Features:**

- High-impact ABS corners
- Standard 3/4" edge
- Patented composite core
- Available in over 50 sizes



## TABLE OPTIONS



RT-3072  
(Shown with Standard leg)



RT-3072  
(Shown with Wishbone leg)



RT-3072  
(Shown with Conference T leg)



RT-3636  
(Shown with Post leg)



RT-1872  
(Shown with Offset Conference leg)



RT-3096 Mobile Buffet™  
(Shown with optional storage rack)



RT-3030  
(Shown with X leg)



RT-3072 MityBrite®  
(Shown with Short Adjustable leg)



RT Cart - Upright



RT Cart - Flat

See additional carts  
on page 18

## LEGS & COLORS



F=Standard Fixed Height



W=Wishbone



A=Adjustable  
25" to 38" in 1" steps



SA=Short Adjustable  
19" to 32" in 1" steps



B=Mobile Buffet



D=Knock-down  
(fixed or adjustable)



Snap leg  
(no gravity ring)



OC=Offset Conference



C=Conference T



L=Post Leg



H=Ladder



X=X29 or X42

### Plastic Textured Finish



Beige Grey Brown Black

### Plastic Smooth Finish



Speckled Beige Speckled Grey Oak

### MityBrite® Table Colors



Brite Royal Blue Brite Crimson Red Multi-color

### Durable Powder Coat Leg Finishes



Black Grey Brown

## SPECIFICATIONS

Size	Seats	Weight	Model	Leg Options
48" x 48"	4	53	RT-4848-F	W, A, SA, 60C, L
36" x 96"	10	61	RT-3696-F	W, A, SA, C, B
36" x 72"	6	49	RT-3672-F	W, A, SA, C, B
36" x 36"	4	31	RT-3636-P	X42, L

Size	Seats	Weight	Model	Leg Options
30" x 96"	10	49	RT-3096-F	W, A, SA, C, B
30" x 84"	8	46	RT-3084-F	W, A, SA, C, B
30" x 72"	6	41	RT-3072-F	W, A, SA, C, B
30" x 60"	4	40	RT-3060-F	W, A, SA, C
30" x 48"	4	35	RT-3048-F	SA, W
30" x 40"	4	32	RT-3040-F	
30" x 30"	4	26	RT-3030-X	X42, L, D

Size	Seats	Weight	Model	Leg Options
24" x 96"	5	47	RT-2496-F	A, SA, C
24" x 84"	4	43	RT-2484-F	A, SA, C
24" x 72"	3+	38	RT-2472-F	A, SA, C
24" x 60"	3+	37	RT-2460-F	A, SA, C, OC
24" x 48"	2+	30	RT-2448-F	SA
24" x 38"	2+	18	RT-2438-F	

Size	Seats	Weight	Model	Leg Options
18" x 96"	5	37	RT-1896-H	OC
18" x 84"	4	36	RT-1884-H	OC
18" x 72"	3+	33	RT-1872-H	OC
18" x 60"	3+	31	RT-1860-H	OC



Tables are standard 29" high, 30" upon request

*Mity-Lite tables are built tough, yet they don't weigh a ton.*



Our tables are so durable, you'll save time and money in replacement and repair. All Mity-Lite tables are backed by our rock-solid 12 year warranty and unbeatable customer service.

To customize tables for specific needs, call factory direct at 1-800-327-1692.

Are you also in the market for chairs? Mity-Lite **banquet-style chairs** are a great choice. See page 10 for details.

**Benefits:**

- Light weight tables reduce personnel injuries
- Far more resilient than hollow plastic tables
- Internal steel leg mounts offer greater strength
- Accidental drops won't damage edges
- Ease of handling reduces set-up/take down labor
- Tough construction cuts replacement and repairs
- Excellent customer service
- 12-year warranty

**Features:**

- Durable cold-rolled steel legs
- High-impact table top
- Patented inner support
- Many sizes and shapes available



## TABLE OPTIONS



CT-72  
(Shown with Conference leg)



CT-60  
(Shown with Standard leg)



ST-3672  
(Shown with Standard leg)



CT-60 MityBrite®  
(Shown with Standard leg)



CT-36  
(Shown with X-leg)



CT-30  
(Shown with Adjustable leg)



HR-60  
(Shown with Standard leg)



QR-30  
(Shown with Post legs)



CT Cart-Edge Narrow



CT Cart-Large X

See additional carts  
on page 18

## LEGS & COLORS



F=Standard Fixed Height



W= Wishbone



A=Adjustable  
25" to 38" in 1" steps



SA=Short Adjustable  
19" to 32" in 1" steps



D=Knock-down  
(fixed or adjustable)



Snap leg  
(no gravity ring)



H72=Ladder style leg for CT72



60C=60 inch Conference leg



72C=72 inch Conference leg



L=Post Leg



X=X29 or X42

### Plastic Textured Finish

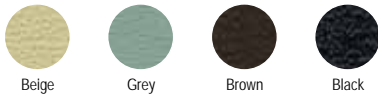

### Plastic Smooth Finish



### MityBrite® Table Colors



### Durable Powder Coat Leg Finishes



## SPECIFICATIONS

Size	Seats	Weight	Model	Leg Options	Size	Seats	Weight	Model	Leg Options	Size	Seats	Weight	Model	Leg Options
72" Round	12	81	CT-72-72C	H72	96" Half Round	8	71	HR-96-F		30" x 60" Serpentine	6	49	ST-3060-F	
66" Round	10	71	CT-66-F	W	72" Half Round	6	40	HR-72-F		36" x 72" Serpentine	8	66	ST-3672-F	
60" Round	8	59	CT-60-F	A, W, SA, 60C	60" Half Round	4	32	HR-60-F						
54" Round	6	49	CT-54-F	W	24" Quarter Round	2	18	QR-24-L						
48" Round	4	41	CT-48-F		30" Quarter Round	3	21	QR-30-L						
48" Round Plycore	4	48	CT-48-L	X	36" Quarter Round	3	24	QR-36-L						
42" Round Plycore	4	45	CT-42-L	X										
36" Round Plycore	4	26	CT-36-X	X42, D, L										
30" Round Plycore	3	24	CT-30-X	X42, D, L										
24" Round Plycore	2	15	CT-24-X21	X, X21, D, L										
72" Oval w/Extreme Edge	12	73	OT-6072-F											



**SwiftSet® Folding**  
Frame: Silver – Plastic: Brite Royal Blue



**SwiftSet® Stacking**  
Frame: ML Grey – Plastic: Wine

**Design**  
your own  
**SwiftSet®!**  
Visit [mitylite.com](http://mitylite.com) to choose your colors.

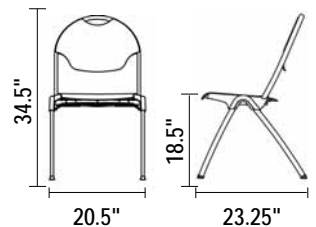
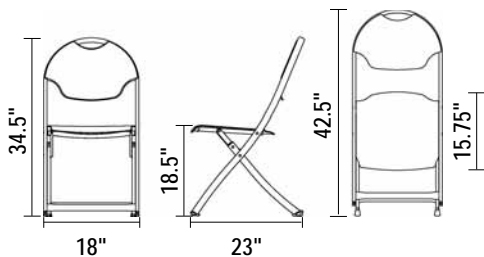

*Mity-Lite SwiftSet® folding & stacking chairs are incredibly lightweight and durable.*



They weigh in at only 11.5 pounds—yet each chair is engineered to hold half a ton! Choose from a variety of styles and colors. We'll even add your logo.

Call 1-800-327-1692 to learn about our frame and color

options. Or visit [www.mitylite.com](http://www.mitylite.com) to try our interactive "Design your own SwiftSet®" tool. Experiment with different colors before you buy!

Our **folding tables** are a great complement to your SwiftSet® chairs. See pages 2-5 for details.

**Benefits:**

- Tough yet lightweight design
- Safe, even weight distribution with 1000 lb. capacity
- Easy set-up and take down (Less time and labor)
- Extremely durable with little or no maintenance
- Superior lumbar support for greater comfort
- Ultra-compact stacking for efficient storage
- 12 year warranty and excellent customer support

**Features:**

- Strong steel tubing
- Tough powder coat finish
- UV stabilized for outdoor use
- Stain resistant texture
- Non-marring feet



## CHAIR OPTIONS



SwiftSet® Folding



SwiftSet® Folding Upholstered



Stacks Densely



Ganging Options



SwiftSet® Cart - Flat



SwiftSet® Stacking



SwiftSet® Stacking Upholstered



Stacks Densely



Ganging Options

See additional carts on page 19



SwiftSet® Cart - 2 Wheel

## GRAPHICS & COLORS



Embroidery



Interfused Graphic\*



Screenprinting



Visit [www.mitylite.com](http://www.mitylite.com) for complete fabric selection. Samples available upon request. (Optional TB133 upgrade available)

### Plastic & Frame Colors



Navy Blue



Brite Royal Blue



Midnight Blue



Seafoam



Forest Green



Orange



Brite Crimson Red



Wine



Spice



Purple



Mocha



Sun Gold



Brite Green



Golden Yellow



Brite Yellow



ML Beige



Bone



Off-White



White



ML Grey



Brown



Black



Silver



Gun Metal

### Frame Only Colors

## SPECIFICATIONS

Model	Seat Height	Overall Height	Width	Weight	Seat Depth	Footprint
Folding	18.5" (47cm)	34.5" (88cm)	18" (46cm)	11.5 lbs. (5.2kg)	15.75" (40cm)	L 23"x W 18" (58 x 36cm)
Folding (Upholstered)	19" (48.2cm)	34.5" (88cm)	18" (46cm)	13.8 (6.3kg)	15.75" (40cm)	L 23"x W 18" (58 x 36cm)
Stacking	18.5" (47cm)	34.5" (88cm)	20.5" (52cm)	11 lbs (5kg)	16" (40cm)	L 23.25"x W 21" (59cm x 53cm)
Stacking (Upholstered)	19" (48.2cm)	34.5" (88cm)	20.5" (52cm)	13.5 lbs (6.2kg)	16" (40cm)	L 23.25"x W 21" (59cm x 53cm)



**New!**



SwiftSet® Courtside™ Chairs



**2006 Platinum Award Winner!**



Visit [www.mitylite.com](http://www.mitylite.com) for complete fabric selection. Samples available upon request. (Optional TB133 upgrade available)

SwiftSet® Courtside™ Flip seat Folding Chair  
Frame: Black – Fabric: Black vinyl

**Plastic Colors**



**SPECIFICATIONS**

	Seat Height	Overall Height	Overall Width	Seat Depth	Footprint
Set Up Position	18.5" (47cm)	35.5" (90cm)	18" (46cm)	15" (38cm)	19" L x 18" W (48cm x 46cm)
	Overall Length	Overall Thickness	Overall Width	Weight	Stack Density
Folded Position	42.5" (108cm)	7" (18cm)	18" (46cm)	14.5" (6.6kg)	1st chair 7" +4.75" per additional chair

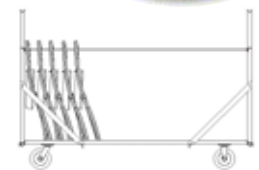
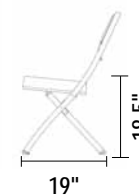

SwiftSet® Cart-Stacking

See cart details on page 19

**SwiftSet® Courtside™ chairs—for convenient flip seat functionality.**



With a padded stadium style flip seat, the SwiftSet® Courtside™ chair is ready for use in sports and church arenas, or anywhere a comfortable flip seat folding chair is needed.

To learn about frame and fabric options, call 1-800-327-1692 to speak with a representative.

Have you tried our DuraMax™ resin folding chairs? See page 13 for details.

**Benefits:**

- Durable construction with 1,000 lb. capacity
- Time saving, single handed set-up and takedown
- Safe & convenient flip seat
- Greater comfort with built-in lumbar support
- Writable/erasable seat label for custom numbering
- Wide variety of frame colors & fabrics
- 12-year warranty

**Features:**

- Strong 18 gauge steel tube frame
- Light, yet tough polypropylene seat base
- Plush 2 1/2 inch seat foam
- Long-lasting powder coat finish



**New!**



SwiftSet® HD™ High Density Stacking Chair  
Frame: Chrome – Plastic: Black

See additional carts on page 19



SwiftSet® HD™ Chairs



SwiftSet® HD™ Cart



Ganging Mechanism

**Standard Plastic Colors**

(Quick ship program available. Call rep for details.)



**Additional Plastic Colors**

(Upcharge or minimum order quantity may apply.)



**SPECIFICATIONS**

Seat Height	Overall Height	Width	Weight	Seat Depth	Footprint
18.75" (48cm)	34.75" (88cm)	22.5" (57cm)	16.5 lbs. (7.5kg)	17" (43cm)	23.25" L x 22.5" W (59cm x 57cm)

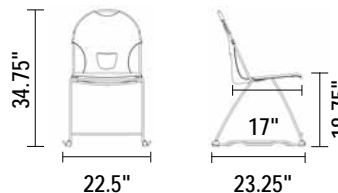

*SwiftSet® HD™ chairs— for comfortable use and dense storage.*



Enjoy the sleek contours and innovative style of Mity-Lite's new SwiftSet® HD™ chair. It's a convenient, durable seating solution for training and conference facilities, convention centers and more.

For details, call 1-800-327-1692 to speak with a representative.

Our conference-style tables go well with SwiftSet® HD™ chairs. See pages 2 and 3 for details.

**Benefits:**

- Safe, even weight distribution with 1000 lb. capacity
- Straight-up stacking—no starter cart needed!
- Secure set up with built-in ganging system
- Comfortable seat features flexible lumbar support
- UV protected for outdoor use
- Available in a wide variety of colors
- 12-year warranty

**Features:**

- Durable 11.2mm & 12mm steel frame
- Strong polypropylene seat and back
- Smooth, non-snag edges
- Tough chrome finish



**Design**  
your own  
**Host Chair!**

Visit [mitylite.com](http://mitylite.com) to choose your colors.



**Lightest Flex Chair Available!**

Rated for  
1.5 million flexes.

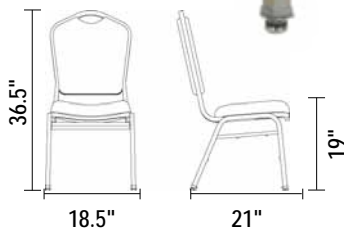

**Deluxe Host™ 410**  
Frame: Brass – Shape: Crown  
Pattern: Interval – Color: Sunset

**Deluxe Host™ 440 Flex back**  
Frame: Silver – Shape: Crown  
Fabric: Giselle – Color: 6454

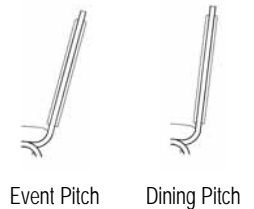

*Enjoy the style and comfort of our stacking banquet chairs.*



Choose from hundreds of fabrics and a variety of frame colors for your ideal custom solution!

To customize your Deluxe Host™ 400 chairs, call us at **1-800-327-1692**. Or visit [www.mitylite.com](http://www.mitylite.com) to try our interactive "Design your own Host" tool. Experiment with different frames and fabrics before you buy.

Have you seen our durable **folding tables**? They'll complement your chairs perfectly. See pages 2-5 for details.

**Benefits:**

- Lightweight handling for faster set-up and take down
- Superior durability with cold-rolled steel frame and legs
- Plush comfort with dense foam and distinctive smile-bend frame
- Long lasting seat with tough polypropylene base
- Complete customization with hundreds of fabrics available
- Convenient storage with optional carts
- 15-year warranty

**Features:**

- Durable construction holds 1000 pounds
- Strong 7/8" 18 gauge steel frame
- 2 anti-sway bars
- 8 anti-mar stack buttons
- 4 back styles



## CHAIR OPTIONS

### Deluxe Host™ 410



(Shown with Round Back)\*

### Deluxe Host™ 420 Armchair



Floating & Fixed Arms  
(Shown with Oval & Crown Backs)\*

### Deluxe Host™ 440 Flex Back



(Shown with Crown Back)\*

### Deluxe Host™ 460 Generous Size



(Shown with Square Back)\*

\* Available in all back shapes

See additional carts  
on page 19



Optional Basket



Optional Hymnal Holder



Frame Ganging



Stack Bar Ganging



Host Cart – 4 Wheel

## COLORS & FABRICS



Visit [www.mitylite.com](http://www.mitylite.com) for complete fabric selection.  
 Samples available upon request.  
 (Optional TB133 upgrade available)

## SPECIFICATIONS

Shape	Seat Height	Overall Height	Width (Standard)	Width (Armchair)	Depth	Weight
Round	19" (48cm)	36" (92cm)	18.5" (47cm)	24.25" (61.5cm)	15.75" (40cm)	13.85 lbs. (7kg)
Oval	19" (48cm)	36" (93cm)	18.5" (47cm)	24.25" (61.5cm)	15.75" (40cm)	13.65 lbs. (7kg)
Square	19" (48cm)	34.75" (88cm)	18.5" (47cm)	24.25" (61.5cm)	15.75" (40cm)	13.95 lbs. (7kg)
Crown	19" (48cm)	36.5" (93cm)	18.5" (47cm)	24.25" (61.5cm)	15.75" (40cm)	13.95 lbs. (7kg)
Flex	19" (48cm)	Varies	18.5" (47cm)	24.75" (62.8cm)	15.75" (40cm)	15.5 lbs (8kg)
Generous Size	19" (48cm)	+ 1.5" (3.8cm)	20.5" (52cm)	26.25" (66.5cm)	15.75" (40cm)	14 lbs (7kg)



Round Back



Oval Back



Square Back



Crown Back



SteelCore™ Resin Chiavari Chair  
Frame: Gold – Cushion: Ivory



Ice  
(Clear Resin)



Black



White



Silver

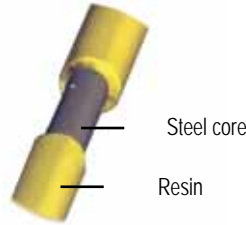

Steel core provides greater stability



SteelCore™ Chair Cushions  
(White, Burgundy, Ivory, Black)

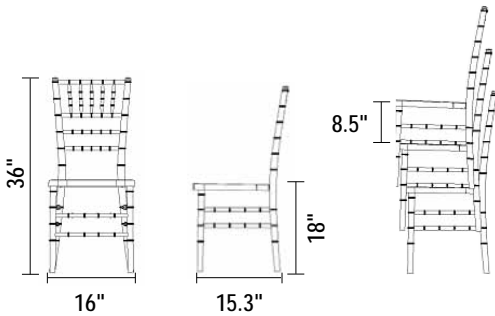

**SPECIFICATIONS**

Seat Height	Overall Height	Width	Weight	Seat Depth	Footprint
18" (45cm)	36" (93cm)	16" (40cm)	13 lbs. (5.3kg)	16" (40cm)	15.3" L x 16" W (39cm x 41cm)

*SteelCore™ Resin Chiavari chairs— for unexpectedly durable elegance.*



Steel piping runs throughout the resin legs and chair frame—giving you the strongest, most stable Chiavari chair available! Perfect for use wherever the exotic Chiavari look is desired.

Call **1-800-327-1692** for information on our SteelCore™ line.

Need custom tables for your chairs? See Mity-Lite **folding tables** on pages 2-5.

**Benefits:**

- Reinforced for greater stability
- Greater stability means reduced liability
- 1,000+ lbs. static load capacity
- No sanding or painting needed
- Interstacks with most wood Chiavari chairs
- Three-year warranty

**Features:**

- Steel reinforced legs and back
- 100% premium resin
- Non-stick, anti-static finish
- UV protected



DuraMax™ Resin Folding Chair  
Frame: Black



Grey



White



Taupe



All Purpose Dolly  
(for SteelCore™ & DuraMax™ Chairs)



Chair Ganging

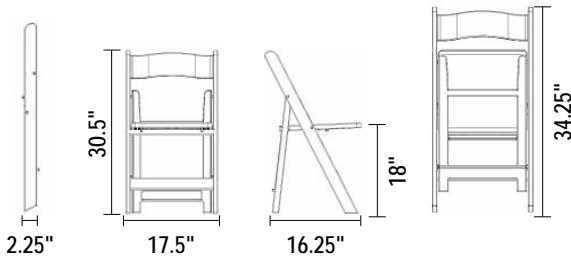

**SPECIFICATIONS**

Seat Height	Overall Height	Width	Weight	Seat Depth	Footprint
18" (45cm)	30.5" (79cm)	17.5" (44cm)	11.5 lbs. (5kg)	14.25" (36cm)	16.25" L x 17.5" W (41cm x 44cm)

*DuraMax™ Resin Folding chairs—for a classic “wedding chair” look.*



DuraMax's special stain-resistant resin makes cleaning and maintenance easy, while the durable construction ensures safe and stable use. Your best choice for a classic event chair!

To learn more, call 1-800-327-1692.

Need portable partitions for your event? See pages 16-17 for details.

**Benefits:**

- Unique straight leg design for greater stability
- Rust-free construction with stainless steel hardware
- 1,000+ lbs. static load capacity
- No sanding or painting required
- Perfect for all indoor and outdoor events
- Designed to match existing wood folding chairs
- Three-year warranty

**Features:**

- Reinforced back legs
- Frame-to-frame aluminum seat support
- Non-stick, anti-static finish
- UV protected



C1-2330 Round



C1-2420 Oval



C1-2320 Diamond

Frame Colors



Visit [www.mitylite.com](http://www.mitylite.com) for complete fabric selection. Samples available upon request.

C1-2430 Crown

Frame: Metallic Gold – Shape: Crown  
Pattern: Surge – Color: Night Blue



88"



18"



20"

19"

SPECIFICATIONS

Shape	Seat Height	Overall Height	Width	Depth	Weight	Stack Height
Round	19" (48cm)	36" (92cm)	18" (47cm)	15.75" (40cm)	12.5 lbs. (5.6kg)	78.25" (199cm)
Oval	19" (48cm)	36.5" (93cm)	18" (47cm)	15.75" (40cm)	12.5 lbs. (5.6kg)	78.25" (199cm)
Diamond	19" (48cm)	36.5" (93cm)	18" (47cm)	15.75" (40cm)	12.5 lbs. (5.6kg)	78.25" (199cm)
Crown	19" (48cm)	36.5" (93cm)	18" (47cm)	15.75" (40cm)	12.5 lbs. (5.6kg)	78.25" (199cm)

*Benefit from the no-nonsense performance of our Mity-Lite® Classic chair.*



Perfect for those on a tight budget, who require a comfortable, quality chair.

To learn how Mity-Lite® Classic banquet chairs can meet your needs, call 1-800-327-1692.

Need lightweight folding tables to complement your Mity-Lite chairs? Please see pages 2-5 for details.

Benefits:

- Lightweight design for easy handling
- Comfortable seat and back
- Quality selection with several fabrics and colors
- 10-year warranty

Features:

- Sturdy 3/4" 18 gauge steel frame
- Anti-sway bars
- 8 anti-mar stack buttons
- Multiple back shapes





**Summit™ Lectern**  
 Style: Full Size – Shell: Black  
 Insert: Natural Maple – Logo: Black Brass



**Summit™ Lectern**  
 Style: Table Top – Shell: Black  
 Insert: Select Cherry – Logo: Black Brass



Lectern Dashboard

**Shell Colors**

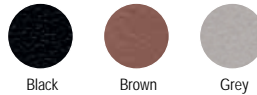

**Insert Colors**



**Custom logos**

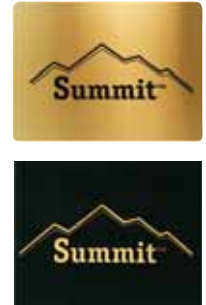

Brass, Black Brass (shown), Silver, Wood and Full Color Options

**SPECIFICATIONS**

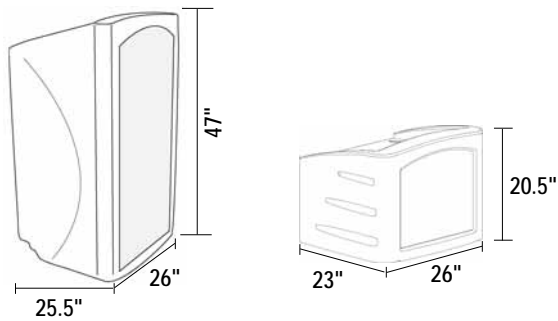

Model	Height	Width	Depth	Weight
Full Size–Basic	47"	26"	25.5"	53 lbs.
Full Size–Standard	47"	26"	25.5"	59 lbs.
Full Size–Deluxe	47"	26"	25.5"	63 lbs.
Full Size–Executive	47"	26"	25.5"	68 lbs.
Full Size–Presidential	47"	26"	25.5"	76 lbs.

Model	Height	Width	Depth	Weight
Table Top–Basic	20.5"	26"	23"	25 lbs.
Table Top–Standard	20.5"	26"	23"	30 lbs.
Table Top–Deluxe	20.5"	26"	23"	39 lbs.
Table Top–Executive	20.5"	26"	23"	41 lbs.

*Looking for a lightweight, durable lectern?*



Each Mity-Lite® Summit™ lectern is sleekly designed and manufactured with the finest materials available. So you'll get extreme durability at an excellent value.

To ask about lectern options, call us at 1-800-327-1692.

Have you tried our durable **folding tables and chairs**? See pages 2 and 6 for details.

**Benefits:**

- Durable polyethylene shell with 6-foot drop rating
- Lightweight mobility with built-in wheels
- Superior resilience with crack-resistant shell
- Fully customizable with sound and electronics
- Superior customer support and warranty

**Features:**

- Full size or Table top styles
- Custom graphics
- Removable front inserts



**VersiPanel™**  
Size: 6'x12' - Color: Pewter

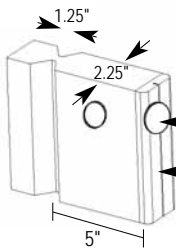

- 20 lb. rare earth magnets
- End runners are made of MDF (Medium Density Fiber) board.



Multipurpose use



VersiFoot® Support

**Fabric Colors**

(Visit [mitylite.com](http://mitylite.com) for more color options)

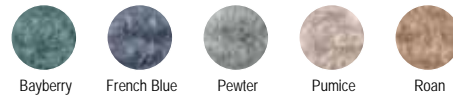

**SPECIFICATIONS**

Heights	Lengths	Weights
2 - 8 Feet in 1/2 ft increments	4 - 15 Feet in 1/2 ft increments	Weight Formula: H x L x .8 = lbs.

*Need more flexibility?*



With building costs rising, customers are looking for ways to maximize their existing facility space. With VersiPanel™ portable partitions, you can easily create additional office space, portable meeting areas and more.

To discover a wide variety of VersiPanel™ uses, call us at 1-800-327-1692.

Could we also interest you in our world-famous folding tables? See pages 2-5 for details.

**Benefits:**

- Lightweight for easy set-up and take down
- Flexible panels curve and shape for a pleasing effect
- Sound absorbing material reduces noise flow
- Many configurations for multipurpose use
- Stable, free-standing panels install tool free
- Wide variety of heights and lengths

**Features:**

- Acoustic ribbed fabric
- Velcro® compatibility
- Self-healing construction
- Powerful rare earth magnets for multiple panel set-ups



Unique combinations



Easy set-up

**Fabric Colors**

(Visit [mitylite.com](http://mitylite.com) for more color options)

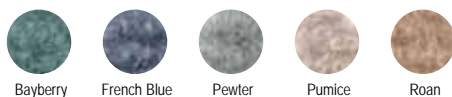

Bayberry French Blue Pewter Pumice Roan

**VersiFold™**  
Size: 6'x8' – Color: Roan

**SPECIFICATIONS**

Height	Length	Weights
6 Feet	8 Feet	88-124 lbs (Weight depends on optional accessories selected)

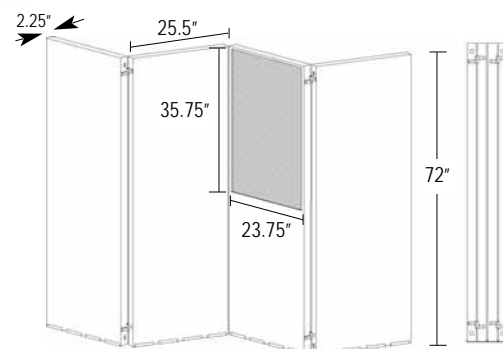

*Want more versatility?*



To minimize facility costs, customers are turning to Mity-Lite for fast alternatives. Our easy-to-use VersiFold™ portable partitions help you create instant meeting areas, convenient portable classrooms and more.

To learn how VersiFold™ can help you create more multi-purpose space, call 1-800-327-1692.

Have you tried our extremely durable **folding chairs**? See page 6 for details.

**Benefits:**

- Lightweight for easy handling and storage
- Folding panels hold their shape for long-lasting quality
- Acoustic material reduces noise flow from other areas
- Unique design protects from finger pinching
- Free-standing panels are stable & safe
- Fast, easy set-up for a variety of configurations

**Features:**

- Acoustic ribbed fabric
- Velcro® compatibility
- Powerful rare earth magnets for multiple panel set-ups
- Optional chalkboard and whiteboard accessories



**RT Cart—Flat**  
*Holds: (10) RT tables*  
 PART #: CRT2460FBLK2



**RT Cart—Upright**  
*Holds: (7) RT tables from 72—96 or (5) RT tables 48—60*  
 PART #: CRTRTUBLK2

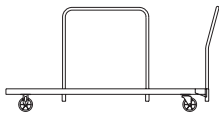

**RT Cart—Edge**  
*60 holds (10) RT 1860, 2460, 3060 tables*  
*72 holds (20) 3636 or (10) RT 1872, 2472, 3072, 3672 tables*  
*96 holds (10) RT 1896, 2496, 3096, 3696 tables*  
 PART #: CRT18-60EBLK2

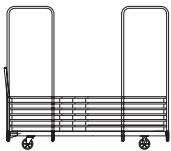

**RT Cart—Double Capacity**  
*Holds: (20) RT 3060, 3072, 3096*  
 PART #: CRT3072DCBLK2

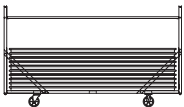

**RT Cart—Stacking\***  
*RT3072 Holds: (15) RT3072*  
*RT3096 Holds: (15) RT3096*  
*RT3672 Holds: (15) RT3672 or (30) RT1872*  
*RT3696 Holds: (15) RT3696 or (30) RT1896*  
 PART #: CRTSKRT3072BLK

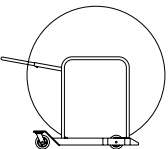

**CT Cart—Edge Narrow**  
*Holds: (6) CT42-CT72*  
 PART #: NARROW W/5" CASTER =CRTCT42-60BLK55

**CT Cart—Edge Wide**  
*Holds: (12) CT42-CT72*  
 PART #: WIDE W/5" CASTER =CRTCT42-72BLK25  
 WIDE W/6" CASTER =CRTCT42-72BLK26

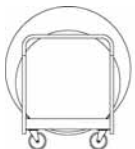

**CT Cart—Small**  
*Holds: (20) CT 24, CT 30, CT 36, RT 3030, RT 3636*  
 PART #: CRTCTS30-36BLK2

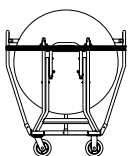

**CT Cart—Small X**  
*Holds: (9) CT30-X, CT36-X, RT3030, RT3636*  
 PART #: CRT30-36SXBLK2

**CT Cart—Large X**  
*Holds: (8) CT42-X, CT48-X*  
 PART #: CRT42-48LXBLK2

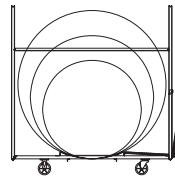

**CT Cart—Stacking\***  
*CT60 Holds: (10) CT 60, CT 54 or CT 48*  
*CT72 Holds: (10) CT 72*  
 PART #: CRTSKCT60BLK

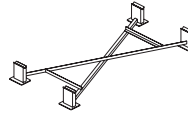

**X-Base—Stacking\***  
*Holds: X-Base holds (3) RT/CT Cart—stacking*  
 PART #: XBCT60BLK

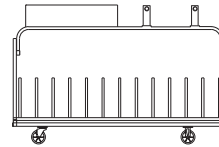

**CT/RT Cart 24—Knockdown**  
*Holds: (24) disassembled Knockdown style tables*  
 PART #: CRTDLBLK2

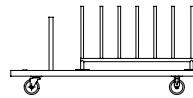

**CT/RT Cart 12—Knockdown**  
*Holds: (12) disassembled Knockdown style tables*  
 PART #: CRTDLBLK4

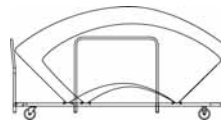

**Serpentine Cart—Edge**  
*Holds: (8) Serpentine tables*  
 PART #: CRTSERPEBLK2

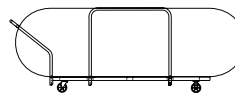

**OT Cart—Large**  
*Holds: (10) OT36120, RT42102, RT48120*  
 PART #: CRTOTLGBLK2

## VERSIFOLD CART



**VersiTruck®**  
*Holds: (4) VersiFold® sections stacked vertically on truck.*  
 PART#: 11018



**SwiftSet® Cart—Flat**

Holds: (45) SwiftSet® non-upholstered (regular), will not hold upholstered chairs or chairs with ganging

PART #: CRTCHSSFBLK2



**Generous Size Host Cart\***

Holds: (64) Generous Size Host Chairs or (64) Host Chairs

PART#: CRTSKCHHOBK

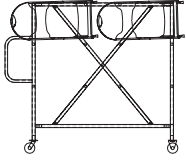

**SwiftSet® Cart—Tree**

Holds: (96) non-upholstered or (72) upholstered chairs

PART #: CRTCHSSTBLK2

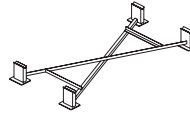

**X-Base—Stacking\***

Holds: X-Base holds (3) SwiftSet® Cart—Stacking

PART #: XBCT60BLK

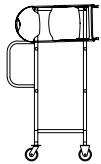

**SwiftSet® Cart—Half Tree**

Holds: (48) non-upholstered or (36) upholstered chairs

PART#: CRTCHSSTBLK2



**Dual Function Cart**

Holds: (40) DuraMax® Resin Folding chairs or (14) SteelCore® Resin Chiavari chairs

PART #: MRCART

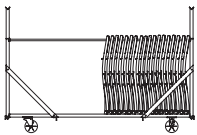

**SwiftSet® Cart—Stacking\***

Holds: (100) non-upholstered or (70) upholstered chairs or (38) SwiftSet® Courtside chairs

PART #: CRTCHSSSKBLK

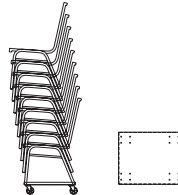

**Host Cart**

Holds: (10) Host chairs

PART #: CRTCHHBLK2

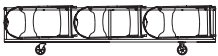

**SwiftSet® Cart—Under-The-Stage**

Holds: (60) non-upholstered or (48) upholstered chairs

PART #: CRTCHSSUSBLK2



**Host / MityTuff® Cart—4 Wheel**

Holds: (10) Host or (12) MityTuff® chairs

PART #: CRT4WCHHTBLK2

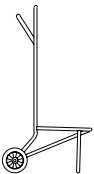

**SwiftSet® Stacking Cart-2 Wheel**

Holds: (15) SwiftSet® Stacking upholstered or non-upholstered chairs

PART #: CRTCSSKBLK2 (TALL) CRTCSSKSHBLK2 (SHORT)

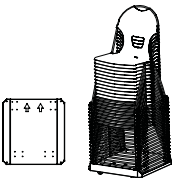

**SwiftSet® HD® Cart**

Holds: (35) SwiftSet® HD® Chairs

PART #: CRTHDTBLK2

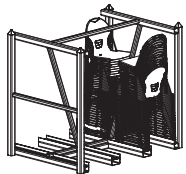

**SwiftSet® HD Cart-Stacking\***

Holds: (120) SwiftSet® HD® Chairs

PART #: CRTSKHDBLK

## WARRANTY

Mity-Lite, Inc. warrants the fabricated steel components of its Carts to be free from defects in materials and workmanship under normal use, service, and handling for a period of twelve (12) years excluding casters which are warranted for a period of one (1) year from the date of purchase.

\* Stacking Carts require a forklift.



Tables accept standard 3/4" clips



Skirting and Linen available



SwiftSet® Cross Bar Cover



Lectern Speaker & Stand



Table Ganging Mechanism



Table Leg Lock



SteelCore™ Chair Storage Cover



VersiPanel™ Wall Mount System



Privacy Panel™

*Give your Mity-Lite furniture a custom look with a wide variety of accessories.*



Check out our drapes, clips, covers, and other options for creating your own unique look and feel.

To learn about our full line of product accessories, call 1-800-327-1692.

**Benefits:**

- One-stop shopping with many options
- Durable accessories for multipurpose use
- Specialized add-ons give customized look
- Easily dress up furniture to match any decor
- Superior customer support

**Other Options:**

- Chair ganging
- 1 1/2" skirting clips
- Table and chair imprints
- Powered speaker systems



*Mity-Lite® tables help you create a wide variety of setups. Below are some suggested configurations that will take your next event to a whole new level!*

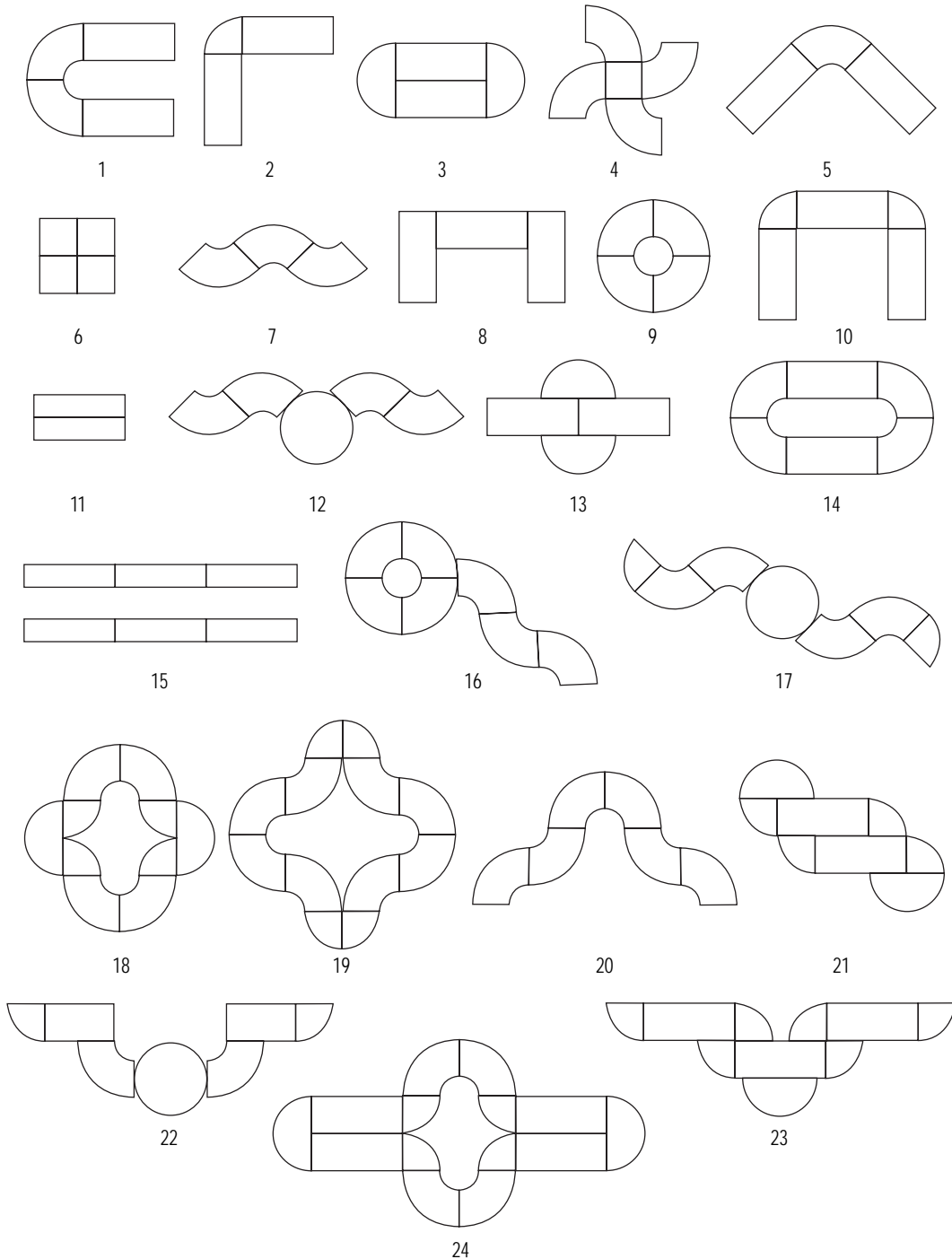

**Tables used in Configurations above:**

- |                                 |                                  |  |   |
|---------------------------------|----------------------------------|--|---|
| 1-Serpentine and Rectangular    | 7-Serpentine                     | 13-Half Round and Rectangular                  | 19-Half Round or Quarter Round and Serpentine         |
| 2-Quarter round and Rectangular | 8-Rectangular                    | 14-Serpentine and Rectangular                  | 20-Serpentine   |
| 3-Half Round and Rectangular    | 9-Serpentine                     | 15-Classroom Setting with 24 inch Rectangulars | 21-Half Round, Quarter Rounds and Rectangular         |
| 4-Serpentine and Square         | 10-Quarter Round and Rectangular | 16-Serpentine                                  | 22-Quarter Rounds, Serpentine, Round and Rectangular  |
| 5-Serpentine and Rectangular    | 11-Rectangular                   | 17-Quarter Round, Round and Serpentine         | 23-Half Round, Quarter Round, Rectangular             |
| 6-Square                        | 12-Round and Serpentine          | 18-Quarter Round, Half Round and Serpentine    | 24-Half Round, Quarter Round, Rectangular, Serpentine |



© 2006 Mity-Lite, Inc 4/1/06